

PHILIPS

Fortimo

LED

Fortimo LED Line 1ft
1100lm 8xx 1R LV4



Datasheet

Fortimo LED Line Gen4

Fortimo LED Line is designed to produce pure white light for general lighting applications with high efficiency levels. The Fortimo LED Line portfolio consists of 2 main ranges of products, which have been differentiated by the number of rows of LEDs on the module. Both ranges feature a variety of different length modules, lumen packages and color temperatures for all the different types of linear luminaires.

Key features and benefits

- State-of-the-art LED module efficiency of up to 186 lm/W
- Instant full light
- Long life-time: >50,000 hours
- High color rendering (CRI >80 and >90)
- Excellent color consistency of 3 SDCM
- Choice of color temperatures (3000, 4000 and 5000 K)
- Two module lengths: 1 ft/280 mm or 2 ft/560 mm
- Three lumen packages: 650, 1100, and 2000 lm per foot/280 mm
- LED module range with 1 or 3 rows of LEDs
- Tunable lumen output, efficacy and lifetime
- Push-in connectors enabling automated wiring
- Wide temperature (Tc) range from -40 °C up to +90 °C
- Five year system warranty

April 2019



indirect



instant



Ordering data

Commercial product name	EOC	12NC	Box quantity
Fortimo LED Line 1ft 1100lm 830 1R LV4	8718696 686508 00	9290 015 42906	180
Fortimo LED Line 1ft 1100lm 840 1R LV4	8718696 686782 00	9290 015 43106	180
Fortimo LED Line 1ft 1100lm 850 1R LV4	8718696 686805 00	9290 015 43206	180

Drive currents

Parameter	Nominal*	Life**	Max***	Unit
Fortimo LED Line 1ft 1100lm 8xx 1R LV4	204	300	380	mA

Module temperatures

Parameter	Nominal*	Life**	Max***	Unit
T _c (case temperature at T _c point)	45	80	80	°C

* Nominal value at which typical performance is specified

** Value at which life time is specified

*** Maximum value for safe operation, do not operate above this value

Optical characteristics - table per color (CCT)

Fortimo LED Line 1ft 1100lm 830 1R LV4

Parameter	Min	Typ	Max	Unit
Luminous flux	967	1045	1126	lm
Module efficacy	148	164	180	lm/W
Correlated color temperature (CCT)		3000		K
Color coordinates (CIEx, CIEy)		(0.430, 0.398)		-
Color consistency			3	SDCM
CRI	80			
Radiation angle		120		deg
Photobiological safety			RG1 unlimited	
$\Delta u'v'$ at 6000 hours			0.007	



R9=7

Measurement precision $\pm 5\%$ for the flux data and $\pm 6\%$ for the efficacy data. Measurement precision for color coordinates ± 0.005 . Measurement precision for CRI ± 1.5

Operation point	830	lm	lm/W
80% I-nom 163mA	Tc 25 °C	867	172
	Tc-nom 45 °C	848	169
	Tc-life 80 °C	810	166
I-nom 204mA	Tc 25 °C	1069	167
	Tc-nom 45 °C	1045	164
	Tc-life 80 °C	998	158
I-life 300mA	Tc 25 °C	1524	157
	Tc-nom 45 °C	1488	154
	Tc-life 80 °C	1420	149

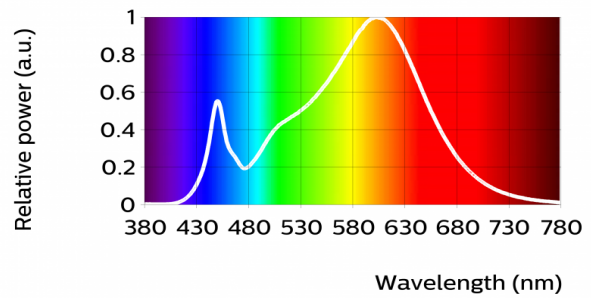

Fortimo LED Line 1ft 1100lm 840 1R LV4

Parameter	Min	Typ	Max	Unit
Luminous flux	1018	1100	1183	lm
Module efficacy	155	173	190	lm/W
Correlated color temperature (CCT)		4000		K
Color coordinates (CIEx, CIEy)		(0.381, 0.378)		-
Color consistency			3	SDCM
CRI	80			
Radiation angle		120		deg
Photobiological safety			RG1 unlimited	
$\Delta u'v'$ at 6000 hours			0.007	



R9=6

Measurement precision $\pm 5\%$ for the flux data and $\pm 6\%$ for the efficacy data. Measurement precision for color coordinates ± 0.005 . Measurement precision for CRI ± 1.5

Operation point	840	lm	lm/W
80% I-nom 163mA	Tc 25 °C	913	181
	Tc-nom 45 °C	892	178
	Tc-life 80 °C	853	172
I-nom 204mA	Tc 25 °C	1126	176
	Tc-nom 45 °C	1100	173
	Tc-life 80 °C	1051	167
I-life 300mA	Tc 25 °C	1604	165
	Tc-nom 45 °C	1567	162
	Tc-life 80 °C	1496	157

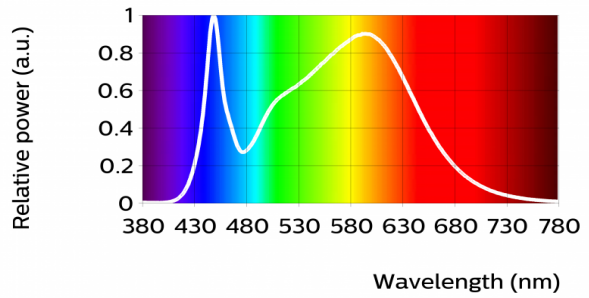

Fortimo LED Line 1ft 1100lm 850 1R LV4

Parameter	Min	Typ	Max	Unit
Luminous flux	1028	1111	1194	lm
Module efficacy	157	174	192	lm/W
Correlated color temperature (CCT)		5000		K
Color coordinates (CIEx, CIEy)		(0.342, 0.350)		-
Color consistency			3	SDCM
CRI	80			
Radiation angle		120		deg
Photobiological safety			RG1 unlimited	
$\Delta u'v'$ at 6000 hours			0.007	



R9=8

Measurement precision $\pm 5\%$ for the flux data and $\pm 6\%$ for the efficacy data. Measurement precision for color coordinates ± 0.005 . Measurement precision for CRI ± 1.5

Operation point	850	lm	lm/W
80% I-nom 163mA	Tc 25 °C	922	182
	Tc-nom 45 °C	901	179
	Tc-life 80 °C	861	173
I-nom 204mA	Tc 25 °C	1137	177
	Tc-nom 45 °C	1111	174
	Tc-life 80 °C	1061	168
I-life 300mA	Tc 25 °C	1620	167
	Tc-nom 45 °C	1583	164
	Tc-life 80 °C	1511	158

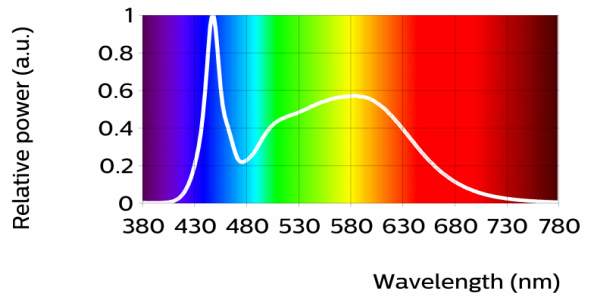

Beam shape

The Philips LED module generates a Lambertian beam shape, which is a pragmatic starting point for OEMs wishing to design secondary optics.

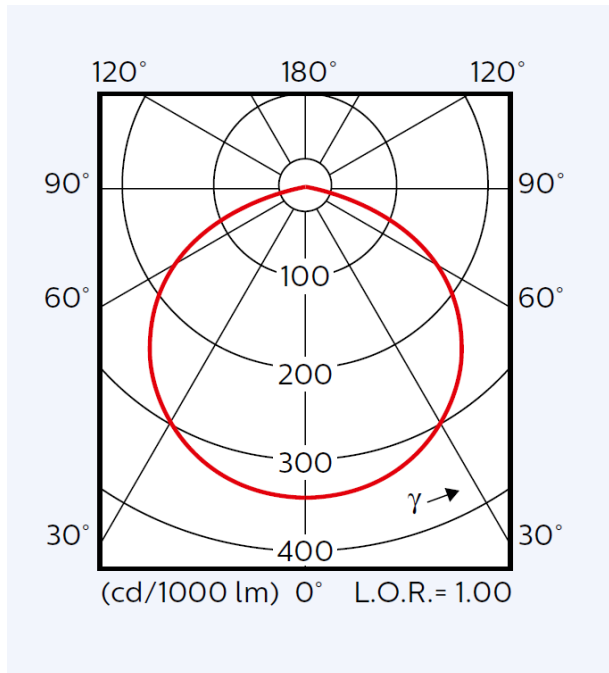

Electrical characteristics

Parameter	Min	Typ	Max	Unit
Forward voltage	30.2	31.2	32.2	V
Power consumption	6.2	6.4	6.6	W = kWh/1000h
Number of modules in series per chain			1	
Number of modules in parallel per chain			5	

Measurement precision for Vf +/- 3%. Measurement precision for power +/- 3.3%
Specifications stated at Tc-nom and I-nom

Tuning information

Flux and efficacy versus current (at Tc nominal)

I [mA]	Flux [%]	Efficacy [%]
300	142	94
245	118	97
204	100	100
184	91	101
163	81	103
143	71	104
122	62	106
102	52	108

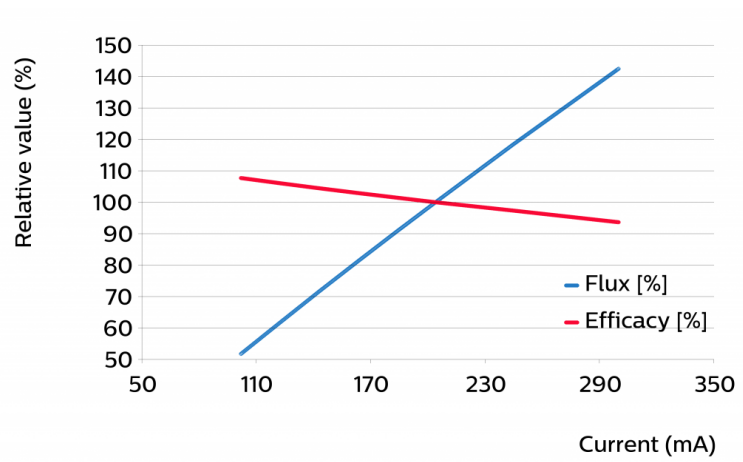

Flux and efficacy versus temperature at Tc (at I nominal)

Tc [°C]	Flux [%]	Efficacy [%]
80	96	97
45	100	100
25	102	102
0	105	103

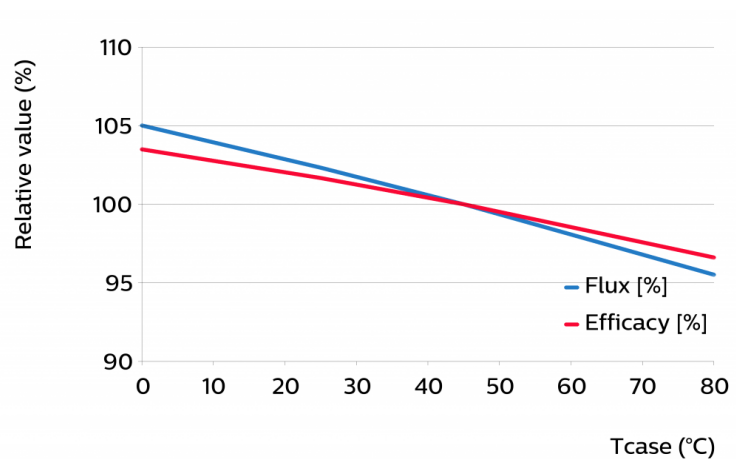

Lumen maintenance

Operation point	Lumen maintenance x 1000 hours	L70			L80			L90		
		B50	B20	B10	B50	B20	B10	B50	B20	B10
80% I-nom 163 mA	Tc 25°C	>70	>70	>70	>70	>70	>70	35	35	35
	Tc-nom 45°C	>70	>70	>70	65	60	60	30	30	30
	Tc-life 80°C	70	70	65	45	40	40	20	20	20
I-nom 204 mA	Tc 25°C	>70	>70	>70	>70	70	70	35	30	30
	Tc-nom 45°C	>70	>70	>70	60	55	55	25	25	25
	Tc-life 80°C	65	65	65	40	40	40	20	20	20
I-life 300 mA	Tc 25°C	>70	>70	>70	65	65	60	30	30	30
	Tc-nom 45°C	>70	>70	>70	55	50	50	25	25	25
	Tc-life 80°C	60	60	55	35	35	35	15	15	15

Lifetime

Parameter	Value	Unit
M70F50 nominal	>70000	hours
M70F50 life	61000	hours

Lifetime L70B50 = 60 0000 hours at I-life and Tc-life. >70 000 hours claim is based on extrapolating raw LM80-data to lower temperatures and currents by using statistical techniques.

Thermal switching table

Calculated number of switches at which the survival rate of the population $\geq 90\%$, at a given ambient temperature and delta T with respect to Tc (where $T_c = T_{ambient} + \Delta T$)

		Tambient [°C]												
		-40	-30	-20	-10	0	10	20	30	40	50	60	70	
delta T [°C] (delta T = Tc - Tambient)	Continuous operation or dimming only	10	> 100 k	> 100 k	> 100 k	> 100 k	> 100 k	>100 k	>100 k	>100 k	>100 k	>100 k	>100 k	>100 k
		20	> 100 k	> 100 k	> 100 k	> 100 k	> 100 k	>100 k	>100 k	>100 k	>100 k	>100 k	>100 k	X
		30	> 100 k	> 100 k	> 100 k	> 100 k	> 100 k	>100 k	>100 k	>100 k	>100 k	>100 k	X	X
		40	> 100 k	> 100 k	> 100 k	> 100 k	> 100 k	> 100 k	>100 k	>100 k	X	X	X	X
		50	69 k	69 k	69 k	69 k	69 k	69 k	69 k	69 k	X	X	X	X
		60	35 k	35 k	35 k	35 k	35 k	35 k	35 k	X	X	X	X	X
		70	19 k	19 k	19 k	19 k	19 k	19 k	X	X	X	X	X	X
		80	12 k	12 k	12 k	12 k	12 k	X	X	X	X	X	X	X
		90	7 k	7 k	7 k	X	X	X	X	X	X	X	X	X
		100	5 k	5 k	X	X	X	X	X	X	X	X	X	X

Wiring

Specification item	Value	Unit	Condition
Input wire cross-section	0.33...0.5	mm ²	stranded wire
	20...22	AWG	stranded wire
Input wire strip length	7.5...8.5	mm	
Input wire cross-section	0.33...0.75	mm ²	solid, fused, stranded
	18...22	AWG	solid, fused, stranded
Input wire strip length	7.5...8.5	mm	

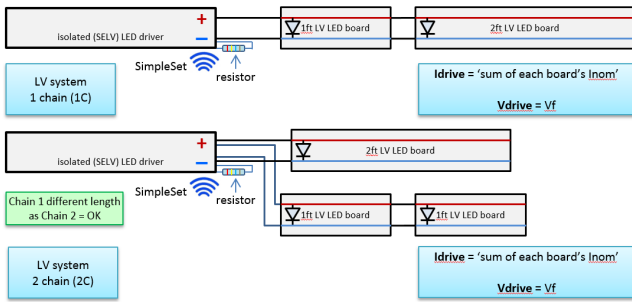

More information in the design-in guide of LED Linear modules.

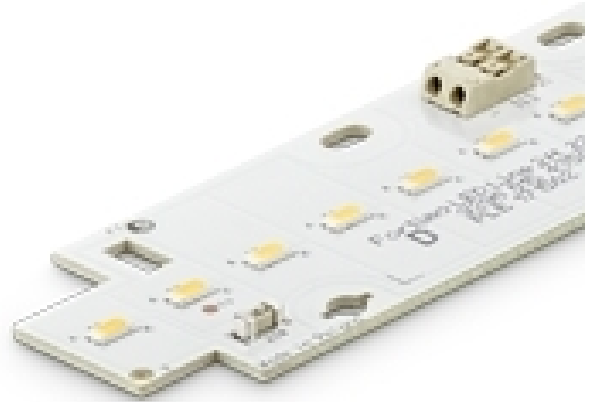

Mechanical characteristics

Parameter	Min	Typ	Max	Unit
Length	279.2	279.7	280.2	mm
Width	39.5	40	40.5	mm
Height excl. connector	4.19	4.29	4.39	mm
Height incl. connector	5.6	5.8	6	mm
Product mass		48		gram

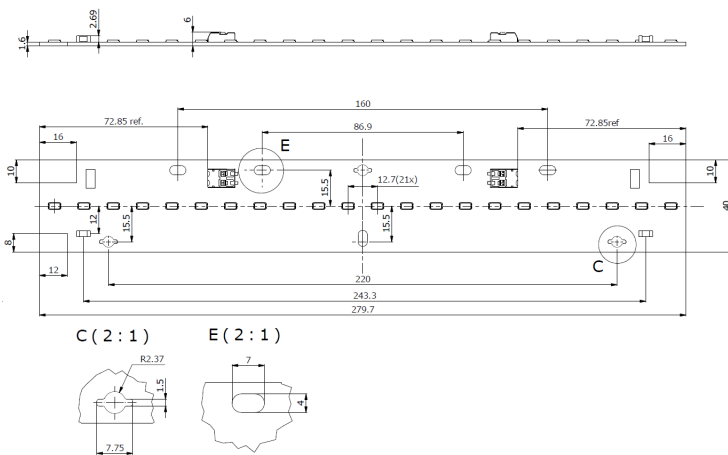

Absolute ratings

Parameter	Min	Max	Unit
Current through the LED module (I-max)		380	mA
Case temperature (Tc-max)		80	°C
Power at rated Vf-max and I-max		13.3	W
ESD (direct contact)		8	kV
ESD (air)		15	kV
Working voltage		120	V _{dc}
Voltage strength	1840		V _{ac}
Ambient temperature	-40		°C

Application information

Certificates and Standards

IEC TR 62778

IEC 62384

IEC 62031:2008 (First Edition) + A1:2012 + A2:2014

Relevant clauses of EN 62471:2008 (With IEC/TR 62471-2: 2009 and IEC/TR 62778: 2014)

UL 8750

ENEC+

CE

ENEC

Zhaga

Compliant*

*L28W4

Application

IP rating

No IP-rating

Overheating protection

No protection

Luminaire class

IEC Class I and IEC Class II

Dimming

Yes

Switching cycles in accordance with EU 1194/2012: >15000



© 2019 Signify Holding, IBRS 10461, 5600VB, NL. All rights reserved. The information provided herein is subject to change, without notice. Signify does not give any representation or warranty as to the accuracy or completeness of the information included herein and shall not be liable for any action in reliance thereon. The information presented in this document is not intended as any commercial offer and does not form part of any quotation or contract, unless otherwise agreed by Signify.

www.philips.com/oem

Philips and the Philips Shield Emblem are registered trademarks of Koninklijke Philips N.V. All other trademarks are owned by Signify Holding or their respective owners.

03/04/2019